

Guide to managing risks of industrial rope access systems

Guidance material

JUNE 2022

Disclaimer

Safe Work Australia is an Australian Government statutory agency established in 2009. Safe Work Australia includes Members from the Commonwealth, and each state and territory, Members representing the interests of workers and Members representing the interests of employers.

Safe Work Australia works with the Commonwealth, state and territory governments to improve work health and safety and workers' compensation arrangements. Safe Work Australia is a national policy body, not a regulator of work health and safety. The Commonwealth, states and territories have responsibility for regulating and enforcing work health and safety laws in their jurisdiction.

ISBN 978-1-76114-146-1 (Online PDF)

ISBN 978-1-76114-147-8 (Online DOCX)

Creative Commons

With the exception of the Safe Work Australia logo, this copyright work is licensed under a Creative Commons Attribution 4.0 International licence. To view a copy of this licence, visit creativecommons.org/licenses In essence, you are free to copy, communicate and adapt the work for non-commercial purposes, as long as you attribute the work to Safe Work Australia and abide by the other licence terms.

Contact information

Safe Work Australia | <mailto:info@swa.gov.au> | www.swa.gov.au

Contents

1. Introduction.....	4
1.1. What is an industrial rope access system?	4
1.2. Who should use this Guide?	5
1.3. How to use this Guide.....	5
2. Who has health and safety duties?	6
2.1. WHS laws in your state or territory.....	7
3. Managing health and safety risks.....	7
3.1. Consultation	7
3.2. The risk management process.....	8
3.3. Training and supervision.....	12
3.4. High risk construction work and safe work method statements	13
4. Safe planning and use of an industrial rope access system	13
4.1. Planning the work.....	13
4.2. Emergency procedures and first aid	14
4.3. Remote or isolated work	14
4.4. Equipment selection, care and maintenance	14
4.5. Anchor systems	15
4.6. Rope protection	28
4.7. Exclusion zones.....	29
4.8. Use of tools and other work equipment.....	29
4.9. Work environment hazards	30
4.10. Hazardous manual tasks	31
4.11. Suspension trauma.....	31
4.12. Overhead electric lines	32
5. Glossary	32
Appendix A – Industrial rope access system checklist.....	35

1. Introduction

Industrial rope access systems can pose a number of work health and safety (WHS) risks. This Guide provides information for duty holders, primarily for persons conducting a business or undertaking (PCBUs), on:

- their duties and obligations under the model WHS laws,
- identifying and assessing the risks from using an industrial rope access system
- control measures to manage the risks, and
- safe planning and use of an industrial rope access system.

1.1. What is an industrial rope access system?

An industrial rope access system is a work positioning system that is used for gaining access to, and working at, a workplace, usually by means of vertically suspended ropes (see Figure 1). Although fall arrest components are used in an industrial rope access system, its main purpose is to gain access to a work area rather than provide backup fall protection.

The system involves using a main working line to access and position around a workplace, while protected by a backup safety system—usually a safety line—to minimise the risk of a fall. Both the working line and safety line should be connected to the worker's harness, and each secured to two anchor points.

An industrial rope access system includes the anchorages and the components that connect a worker to an anchorage or anchorages, including the main and safety ropes, harness, descenders, belay and fall arrest devices, connectors, lanyards, attachment hardware and other related equipment, including rescue equipment.

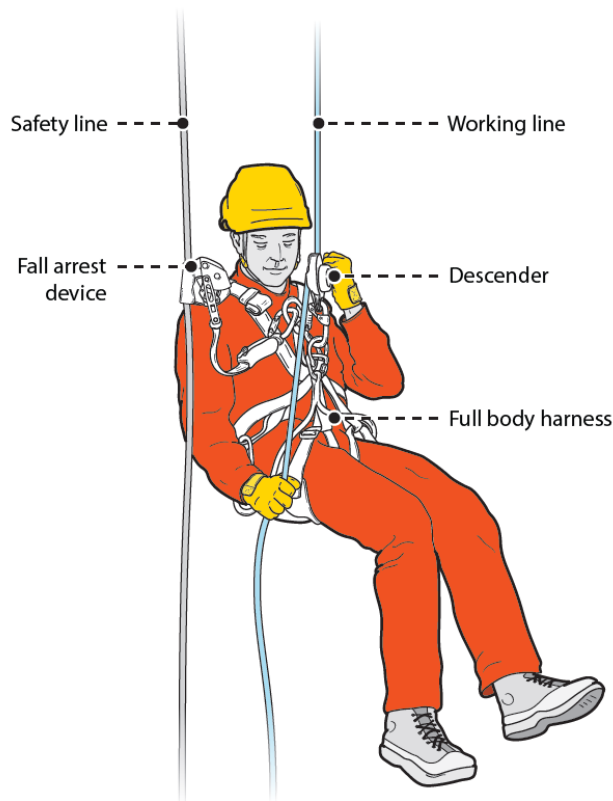


Figure 1 Worker using a descender in an industrial rope access system

1.2. Who should use this Guide?

This Guide provides practical guidance to assist duty holders, primarily PCBUs, to manage risks to health and safety associated with using an industrial rope access system.

You have duties if you:

- engage workers, or cause workers to be engaged, to use an industrial rope access system
- influence or direct workers in use of an industrial rope access system, or
- have management or control of a workplace, or the fixtures, fittings or plant at a workplace, where an industrial rope access system is used.

Duty holders include industrial rope access service providers, building managers, building owners, building body corporates, principal contractors, and other PCBUs at a workplace where an industrial rope access system is used.

This Guide may also assist workers, health and safety representatives, and others in the workplace who may be impacted by the use of an industrial rope access system.

The Guide applies to any workplace where an industrial rope access system is used, including in and around buildings and structures, as well as on or around trees and other natural features. For more information about using rope access systems in arboriculture, see the [Guide for managing risks of tree trimming and removal work](#).

1.3. How to use this Guide

This Guide provides information about the duties and obligations under the model WHS laws and the application of the WHS risk management process to hazards, risks, and control measures that are commonly encountered with industrial rope access systems. The Guide is not able to cover all hazards, risks and control measures in detail. However, examples have been included to assist duty holders in identifying, assessing and managing the risks from an industrial rope access system at their workplace.

In managing the risks, duty holders should also seek the advice of a competent person, for example a qualified rope access technician, and refer to relevant industry guidance and standards. This will ensure you have the most comprehensive information about hazards and risks and the most effective control measures available for the particular workplace.

Conforming with industry guidance and standards for industrial rope access systems does not automatically mean a duty holder is complying with their duties under the model WHS laws. This Guide, together with other information available from Safe Work Australia, will assist you to meet your duties and obligations under WHS laws. It should be read in conjunction with the following:

- [Model Code of Practice: How to manage work health and safety risks](#).
- [Model Code of Practice: Managing the risk of falls at workplaces](#).

This Guide includes references to the legal requirements under the model WHS Act and model WHS Regulations. These are included for convenience only and should not be relied on in place of the full text of the model WHS Act and model WHS Regulations.

In this Guide the word 'must' indicates a legal requirement that must be complied with. The word 'should' indicates a recommended course of action.

2. Who has health and safety duties?

Everyone in the workplace has WHS duties. A range of people have specific duties in relation to industrial rope access systems, including:

- designers, manufacturers, importers, suppliers, and installers of plant and structures
- persons with management or control of the workplace
- officers such as company directors, and
- workers.

The main duty holders are set out in Table 1.

As a duty holder, you must ensure the WHS duties are met, even if others also have the same duty. If you do not take the required action yourself, you must ensure another duty holder is doing so. This requires duty holders to communicate with each other to identify hazards and risks, talk about health and safety concerns, and work together to minimise the risks.

Table 1 Duties in relation to industrial rope access systems

Who	Duties
A person who conducts a business or undertaking (PCBU)	<p>Must ensure, so far as is reasonably practicable, the health and safety of workers, including volunteers, workers the PCBU engages to carry out work, or workers the PCBU directs or influences in carrying out work.</p> <p>Must ensure that the health and safety of other people is not put at risk from work carried out by the business or undertaking.</p> <p>The PCBU with management or control of fixtures, fittings or plant at a workplace must ensure, so far as is reasonably practicable, that the fixtures, fittings and plant are without risks to the health and safety of any person.</p> <p>These duties require the PCBU to manage health and safety risks by eliminating them so far as is reasonably practicable, and if this is not reasonably practicable, by minimising those risks so far as is reasonably practicable.</p> <p>In the model WHS Regulations a PCBU also has a range of other duties in relation to industrial rope access systems, including:</p> <ul style="list-style-type: none"> • managing the risk of falls (regulations 78-80) • managing the risks of plant (regulation 203) • ensuring plant is maintained, inspected and tested (regulation 213) • managing the risks of musculoskeletal disorders relating to hazardous manual tasks (regulation 60) • ensuring suitable and adequate information, training and instruction are provided to workers (regulation 39) • maintaining a secure workplace from unauthorised access (regulation 298), and

Who	Duties
	<ul style="list-style-type: none"> ensuring there is a Safe Work Method Statement for high risk construction work (regulation 299).
Designers, manufactures, importers, suppliers or installers of plant, substances or structures	<p>Must ensure, so far as is reasonably practicable, the plant, substance or structure they design, manufacture, import, supply or install is without risks to health and safety.</p> <p>This duty includes carrying out analysis, testing or an examination, and providing specific information about the plant, substance or structure. Information should be passed on from the designer through to the manufacturer and supplier to the end user.</p>
Officers such as company directors	<p>Must exercise due diligence to ensure the business or undertaking complies with the model WHS Act and Regulations. This includes taking reasonable steps to ensure the business or undertaking has and uses appropriate resources and processes to eliminate or minimise risks to health and safety.</p>
Workers and other persons at the workplace	<p>Must take reasonable care for their own health and safety, comply with reasonable instructions, and not adversely affect the health and safety of other people. Workers must also co-operate with reasonable policies and procedures.</p>

2.1. WHS laws in your state or territory

WHS laws are not the same across Australia. The Commonwealth, state and territory WHS regulators are responsible for enforcing WHS laws in their jurisdiction, investigating incidents and taking enforcement action.

If you need help understanding the WHS requirements in your jurisdiction, please contact your WHS regulator.

3. Managing health and safety risks

As a PCBU, you must manage the health and safety risks associated with the use and maintenance of an industrial rope access system.

Use the following steps to ensure, so far as is reasonably practicable, workers and other persons are not exposed to health and safety risks associated with the use of an industrial rope access system.

Further information on the risk management process is in the [model Code of Practice: How to manage work health and safety risks](#).

3.1. Consultation

As a PCBU, you must consult, so far as is reasonably practicable, with your workers and their health and safety representatives (if any) when deciding how to manage the risks of using an industrial rope access system in the workplace. By drawing on the experience, knowledge and ideas of your workers you are more likely to identify hazards and choose effective control measures.

If there is more than one business or undertaking involved at your workplace or if the workplace is managed or controlled by another PCBU, you must consult them to find out who is doing what and work together, so risks are eliminated or minimised so far as is reasonably practicable.

This may involve discussing workplace-specific control measures including exclusion zones, traffic management, and re-scheduling work that may interfere with the safety of industrial rope access systems.

Further guidance on consultation can be found in the model [Code of Practice: Work health and safety consultation, co-operation and co-ordination](#).

3.2. The risk management process

Risk management requires you to think about what could go wrong at your workplace and what the consequences could be. Then you must do whatever is reasonably practicable to eliminate or minimise those risks. This process will be implemented in different ways depending on the size and nature of your business or undertaking.

Risk management involves four steps:

- **Identify hazards**—find out what could cause harm.
- **Assess risks, if necessary**—understand the nature of the harm that could be caused by the hazard, how serious the harm could be and the likelihood of it happening. This step may not be necessary if you are dealing with a known risk with known control measures.
- **Control risks**—implement the most effective control measure that is reasonably practicable in the circumstances and ensure it remains effective over time.
- **Review hazards and control measures** to ensure they are working as planned.

Determining what control measures are reasonably practicable includes consideration of the availability and suitability of control measures. Cost may also be relevant, but you must only consider this after you have assessed the extent of the risk and the available ways to eliminate or minimise the risk.

Managing the risks of industrial rope access systems requires a high level of competency. You should seek the advice of a competent person, for example a qualified rope access technician, and refer to relevant industry guidance to ensure you have the most comprehensive information about hazards and risks and use the most effective control measures available for the particular workplace.

3.2.1. Identify the hazards

Identifying hazards associated with the use of an industrial rope access system involves finding what could potentially cause harm to people.

The following can help you identify potential hazards:

- Observe the workplace to identify areas where industrial rope access systems may be used. Think about the workplace layout and condition: if there are surfaces or edges that could damage or break rope access equipment; if work is above or near people, vehicles or structures.
- Identify the major functional requirements of the industrial rope access system, like load requirements, available anchor points, and accessibility.

- Inspect industrial rope access systems and equipment before and after use to ensure they are not damaged or excessively worn.
- Identify any hazardous manual tasks such as working with heavy equipment or repetitive strain risks like ascending a working line.
- Consider the potential for falling objects like tools, debris, and equipment such as working lines and safety lines being lowered.
- Assess the workplace environment, including sunlight, wind, weather, and ground conditions.
- Consider other work activities at the workplace, including those above, below, within or near a rope access work area.

You should seek the most comprehensive information about hazards from a competent person and relevant industry guidance.

You should also ask your workers about potential hazards they can see at your workplace and review your incident and injury records including near misses.

A checklist to assist in identifying hazards associated with industrial rope access system is at [Appendix A](#).

3.2.2. Assess the risks

In many cases the risks and related control measures will be well known. In other cases, you may need to carry out a risk assessment to identify the likelihood of somebody being harmed by a hazard and how serious the harm could be.

A risk assessment can help you determine what action you should take to control the risk and how urgently the action needs to be taken.

People who use or work near industrial rope access systems are most at risk. Some of the hazards and risks when using industrial rope access systems include:

- falls from height, including swing down or swing back (pendulum effect)
- falling objects
- collisions with people, plant or structures
- environmental conditions, including solar ultraviolet (UV) radiation, rain, lightning, or winds
- hazardous manual tasks, including working with heavy equipment or ascending a line.

Examples of risk factors to consider include:

- the available anchor systems, e.g. is there an anchor system designed for rope access? Are there independent anchor points for a working line and safety line? Have they been inspected and load tested?
- requirements for rope protection, e.g. to protect from hazardous contact points such as sharp edges or abrasive or hot surfaces
- potential fall distances. Noting that extension of an energy absorber or the elongation of the safety line should be considered to prevent a worker from hitting anything in the event of a fall
- the potential for swing down or swing back (pendulum effect)
- the maximum impact load a rope access worker could exert on a line
- site conditions, e.g. prevailing or unexpected winds and their strength and direction; vehicle traffic, pedestrians or livestock that could interfere with the work

- environmental conditions, e.g. high solar UV radiation, storm activity—heavy rain or lightning in the area
- the type of plant and machinery required e.g. its dimensions, operating characteristics, ease of manoeuvrability and how it will be restrained
- the type of work activities required and the frequency of the work tasks
- the qualifications, competency, skill and experience of the people doing the work
- setting up and packing up procedures, and
- work practices and procedures.

You should seek the most comprehensive information about risks from a competent person and relevant industry guidance.

3.2.3. Take action to control the risks

As a PCBU, you must eliminate risks to health and safety so far as is reasonably practicable. If it is not reasonably practicable to eliminate the risks, you must minimise the risks so far as is reasonably practicable. You will most likely need to use a range of control measures to protect your workers from the risks associated with the use of an industrial rope access system.

Controlling risks should involve discussing site-specific requirements (for example, the type of building materials used on the site or the presence of any known hazards). The ways of controlling risks are ranked from the highest level of protection and reliability to the lowest. This ranking is known as the hierarchy of control measures. You must work through this hierarchy to manage health and safety risks associated with industrial rope access systems.

You should seek advice from a competent person and refer to relevant industry guidance to ensure you use the most effective control measures available for the particular workplace.

3.2.3.1. Managing the risk of a fall

As a PCBU, you must eliminate the risk of a fall from one level to another if the fall is likely to injure a worker or any other person. If it is not reasonably practicable to eliminate the risk of a fall (such as by working on the ground or on a solid construction), you must provide and maintain a safe system of work to minimise this risk. This safe system of work must provide adequate protection against the risk of a fall.

A safe system of work includes:

- providing a fall prevention device, e.g. guard rail, barrier, roof safety mesh, scaffolding, a building maintenance unit, or elevating work platform
- if a fall prevention device is not reasonably practicable, providing a work positioning system, e.g. an industrial rope access system, or
- if neither of these are reasonably practicable, providing a fall arrest system, e.g. a backup safety line, safety net or catch platform, so far as is reasonably practicable.

Providing a work positioning system may not be enough to minimise the risk of a fall. In most circumstances, it is reasonably practicable to also provide a fall arrest system, like a safety line. This is standard practice for industrial rope access systems but must be considered when using any work positioning system.

For more information on managing the risk of a fall at your workplace, see the [model Code of Practice: *Managing the risk of falls at workplaces*](#).

3.2.4. Elimination controls

The first thing you must consider is whether a risk can be completely removed from the workplace. For example, to eliminate the risk of a fall it may be possible to complete certain tasks on the ground.

If it is not reasonably practicable to completely eliminate the risk, then risks must be minimised, so far as is reasonably practicable, by doing one or more of the following:

- substituting the hazard for something safer
- isolating the hazard from people
- implementing engineering controls.

3.2.5. Substitution controls

Substituting the hazard for something safer can be an effective control measure. If it is reasonably practicable, provide a fall prevention device, such as scaffolding, a building maintenance unit, or an elevating work platform. However, if you determine the most appropriate way to minimise risk is to use an industrial rope access system, you should ensure any anchor point used has been determined by a competent person to be suitable for use as an anchor point.

3.2.6. Isolation controls

Isolation involves physically separating the source of harm from people. For example, using a physical barrier to prevent people from entering an area, or installing or placing your industrial rope access anchor devices away from edges where there is a risk of a fall.

3.2.7. Engineering controls

An engineering control is a control measure that is physical in nature, including a mechanical device or process. Examples include using a backup safety line to arrest a fall and using a davit arm to protect lines from sharp edges.

3.2.8. Administrative controls

If risks remain, they should be minimised by implementing administrative control measures, so far as is reasonably practicable. Administrative control measures include:

- warning signs
- supervising access to an exclusion zone
- work methods or procedures that are designed to minimise exposure to a hazard
- information, training and instruction needed to ensure workers can work safely, and
- supervising work to ensure safe work procedures are followed.

Administrative controls are less effective than other control measures because they do not control the hazard at the source and instead rely on human behaviour and supervision. Generally, administrative controls should only be used to supplement other higher level control measures, as a short-term measure or where there are no other practical control measures available.

Some administrative measures will be necessary to ensure substitution, isolation and engineering control measures are implemented effectively, for example, following safe work procedures when using equipment.

3.2.9. Personal protective equipment

Personal protective equipment (PPE) is the least effective method for controlling risk in isolation, however it can be effectively used in conjunction with higher level controls to minimise residual risk.

If workers are required to use PPE at the workplace, you must provide it unless it has been provided by another PCBU. You must ensure it is selected to minimise risk to health and safety. This includes ensuring the PPE is:

- suitable for the nature of the work and any hazard associated with the work
- of suitable size and fit, and
- reasonably comfortable for the worker who is to use or wear it.

For example, a helmet designed for rope access work should always be worn when working with an industrial rope access system. Additional personal protective equipment that may be appropriate includes:

- gloves to protect against cold weather or injury
- slip-resistant footwear
- eye protection where debris is being cleared or material is being removed, or where drilling, cutting or percussion operations are being undertaken
- respiratory protective equipment where there is a risk of inhalation of harmful chemicals or dust
- hearing protection where noise levels could cause risk of hearing damage
- buoyancy or life jackets when working over water, and
- sun protection.

You must also ensure PPE is maintained, repaired and replaced so it continues to minimise risk to the worker who uses it. This includes ensuring the equipment is clean and hygienic, and in good working order.

If you direct the carrying out of work, you must train workers in how to properly use, wear, store, and maintain the PPE. A worker must, so far as reasonably able, use or wear the PPE as instructed and must not intentionally misuse or damage the equipment.

3.2.10. Maintain and review control measures

Check your control measures regularly to ensure they are working as planned. Control measures need to be regularly reviewed to make sure they remain effective, taking into consideration any changes that have affected your work activities, the nature and duration of the work and whether the system is working as planned.

If a Safe Work Method Statement (SWMS) has been prepared due to high risk construction work being done, the SWMS must also be reviewed and revised where necessary.

You should seek advice from a competent person and refer to relevant industry guidance to ensure you have the most comprehensive information about hazards and risks and use the most effective control measures available for the particular workplace.

3.3. Training and supervision

As a PCBU, you must ensure workers are trained to perform their work safely. This includes providing information, training, instruction, and supervision as necessary to protect all persons from WHS risks arising from the business or undertaking. This must take into account the nature of the work, the associated risks and the control measures to be

implemented. You must also ensure industrial rope access workers and supervisors are trained in emergency procedures, including rope rescue techniques.

Rope access system workers, including supervisors, may benefit from undertaking relevant competency-based training before working with an industrial rope access system.

The level of supervision required will depend on the level of risk and the experience of the workers involved. High levels of supervision may be necessary where workers are expected to follow new procedures or carry out difficult and critical tasks. You should ensure supervisors of rope access work have the necessary knowledge, skills, and experience to competently supervise the rope access work. This includes competency in preparing work plans, inspecting and maintaining equipment, and monitoring and reviewing the effectiveness of rope access systems.

3.4. High risk construction work and safe work method statements

The use of industrial rope access systems is considered high risk construction work if it involves construction work where there is a risk of a person falling more than 2 metres (in some jurisdictions this is 3 metres). As a PCBU, you must ensure high risk construction work is not carried out unless a SWMS is prepared for the work.

Further guidance on SWMS is in the [model Code of Practice: Construction work](#).

4. Safe planning and use of an industrial rope access system

4.1. Planning the work

Planning is the first step in ensuring an industrial rope access system is used safely. Planning includes:

- developing a scope of work
- identifying hazards and assessing risks
- selection of appropriate control measures, and
- providing a safe system of work, including planning for emergencies.

Planning for rope access work should start as early as possible, including during the design of a plant or structure, and should involve consultation with all relevant persons. This may include a principal contractor, a building owner, equipment supplier, electricity supply authority, designer, project manager, industrial rope access system workers, and other workers.

Effective planning will help identify ways to protect persons who are:

- selecting, installing, commissioning, inspecting, and dismantling an industrial rope access system
- directly involved in rope access work, including people using an industrial rope access system and the people supporting them
- performing other work activities at the workplace in an area adjacent to the rope access work, including a public area or private property.

When developing safe systems of work involving industrial rope access systems, you should seek advice from a competent person, for example a qualified rope access technician, and refer to relevant industry guidance and Australian standards. For example, *AS/NZS ISO 22846:2020 Personal equipment for protection against falls – Rope access systems*.

4.2. Emergency procedures and first aid

As a PCBU, you must ensure an emergency plan is prepared for the workplace. This includes establishing and testing emergency procedures and providing relevant workers the information, training and instruction they need to implement these procedures.

This means ensuring help is provided promptly to any rope access worker who needs it. You should ensure rope access workers do not work alone. You must ensure relevant workers are trained in emergency procedures, including rope rescue techniques.

You must maintain the emergency plan so it remains effective. This means rescue equipment should be present and ready for immediate use. This equipment should be sufficient to carry out a rescue from any situation on the site. This could be normal rope access equipment, preferably rigged for rescue.

Rigging for rescue involves rigging the working and safety lines with releasable anchors to allow an injured worker to be lowered or raised to a safe location without the need for a rescuer to descend or ascend to the position of the injured worker.

You must ensure workers have access to first aid equipment and facilities for the administration of first aid. You must also ensure an adequate number of workers are trained to administer first aid or the workers have access to people trained in first aid.

4.3. Remote or isolated work

Workers using an industrial rope access system are often isolated from assistance, including rescue, medical assistance, or attendance by emergency service officers. If you cannot eliminate the risks associated with remote or isolated work, as a PCBU, you must minimise these risks by providing a safe system of work. This includes providing effective communication with any isolated worker. You should ensure workers do not work alone and can effectively communicate with each other, and anyone else as necessary, at all times.

The type of communication system will depend on the site-specific conditions, such as the size of the workplace, noise, and weather conditions. Expert advice and local knowledge may be needed to assist with the selection of an effective communication system.

Further information can be found in the [model Code of Practice: *Managing the work environment and facilities*](#).

4.4. Equipment selection, care and maintenance

Equipment used for industrial rope access systems should be designed, manufactured, selected, used and maintained in compliance with relevant standards.

When selecting rope for use in an industrial rope access system, you should consider:

- the maximum impact load a rope access worker could exert on the rope
- the extension or elongation of the rope when identifying potential fall distances
- site conditions, e.g. prevailing or unexpected winds and their strength and direction, high solar UV radiation, possibility of heavy rain, extremes of heat or cold.

You should ensure that a competent person inspects equipment before and after use. This includes personal equipment such as harnesses, lanyards and fall arrest devices and common use equipment such as hardhats, ropes, slings, anchor devices and mobile attachment devices. A **competent person** means a person who has acquired through training, qualification or experience the knowledge and skills to carry out the task.

Ropes and other equipment should be packed away after use, for example when work finishes for the day, and not left set up. This helps ensure it is inspected again before use.

Equipment should be subject to periodic inspection, even if not used regularly, in line with the manufacturer's recommendations and relevant standards.

Any equipment that has arrested a fall or shows a defect should immediately be withdrawn from service and not be used until a competent person can decide whether the equipment should be destroyed, repaired or returned to service. If repaired or returned to service, the equipment should be inspected by a competent person.

All equipment should be maintained in accordance with manufacturer instructions and be stored to ensure it is not exposed to unnecessary strain, pressure, heat, humidity, moisture, solar UV radiation, or chemicals.

4.4.1. Record keeping

As a person with management or control of plant at a workplace, you must keep a record of all tests, inspections, maintenance, commissioning, decommissioning, dismantling, and alterations of plant while it is used or until you relinquish control of it. Records should describe the work carried out, when, and by who. As an example, records must be kept of the testing and condition of installed industrial rope access anchors at a workplace.

Inspection records should include a statement from a competent person confirming the item of plant has been inspected and whether it is safe to use. Inspection records should include:

- What was looked at – component specification or areas of the plant inspected.
- What was looked for – signs of wear, damage, cracking or corrosion.
- What criteria were used – rejection criteria.
- How was it looked for – techniques used.
- What was found – test results, photographs or measurements.
- What was recommended – repairs or replacements required before continued use.
- What recommendations were actioned – recommendations acted upon and date tasks were completed.

4.5. Anchor systems

As a PCBU, you must ensure the provision and maintenance of safe systems of work. For industrial rope access system, this typically means ensuring there are a minimum of two independent anchor points provided and maintained to establish a main working line and a backup safety line. Additional anchor points may be needed for emergency rescues.

Anchors and their supporting structure used as part of an industrial rope access system, either on the working line or safety line, should have a minimum strength of 15 kN. All components of the industrial rope access system should be designed to ensure the total mass of the user and all their equipment is within the capacity of their energy absorber, in accordance with the manufacturer's instructions.

4.5.1. Types of anchor devices

There are many types of anchor devices and it is essential that care is taken when selecting a device. Check it is suitable for the intended use, including the environment it will be used in and the work to be undertaken. Anchor devices should only be used for industrial rope access systems when the manufacturer states it is suitable for personal attachment, including rope access.

Table 2 summarises the common types of anchor devices and their suitability for use in industrial rope access systems. This is intended as general guidance only. Detailed information on the suitability of a device for industrial rope access work should be sought from the plant manufacturer or supplier.

You must ensure anchor devices are installed, tested, and inspected by a competent person, for example a qualified engineer, in accordance with the manufacturer's instructions. This includes confirming the anchor device is suitable for the intended use, the supporting structure (including substrate) can sustain a 15 kN load, and the device is installed correctly and has not damaged the anchor device or the integrity of the supporting structure. If a qualified engineer or similar competent person has certified the design of an anchor installation, but it is not reasonably practicable to have them witness the installation or carry out a site visit, then you must ensure the installer is competent to ensure the anchor device is installed in accordance with the manufacturer's instructions.

Anchors that are permanently installed should be clearly marked with the maximum rated load, intended direction of load, inspection details, and the manufacturer's or installer's details. If it is not reasonably practicable to permanently install an anchor device, the use of a temporary anchor device, such as a sling around a solid structure, is acceptable if it has been determined to be safe by a competent person.

In most cases, the working line and safety line should each be attached to two anchor devices. These anchor devices should be separate and independent from each other, as well as from any anchor points needed for emergency rescues. In some situations, this can mean installing different types of anchor devices for each line.

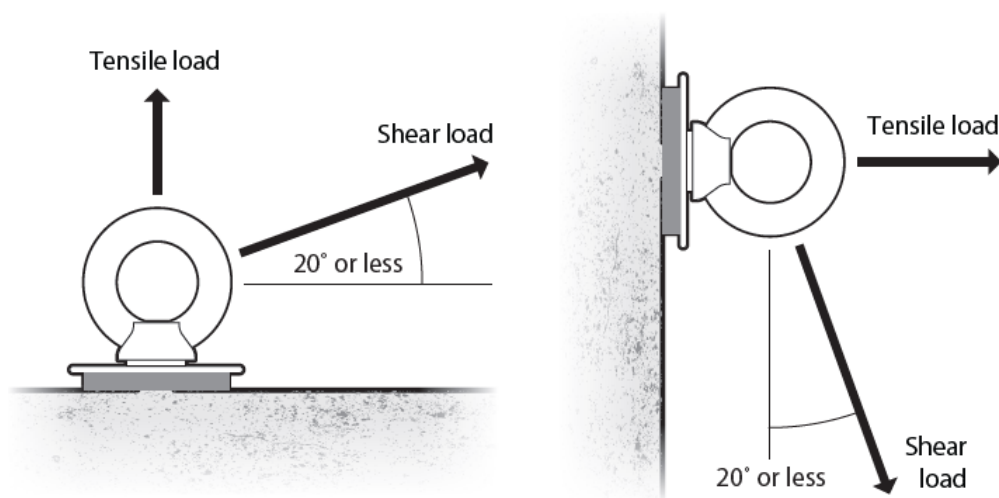
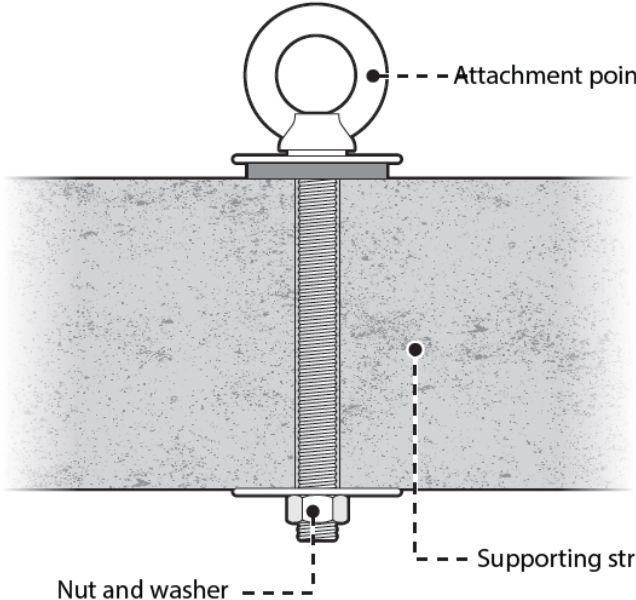

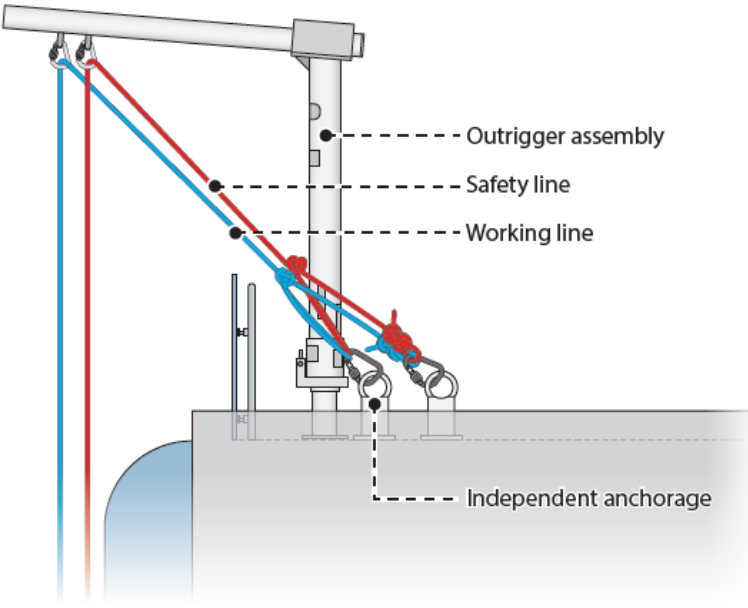

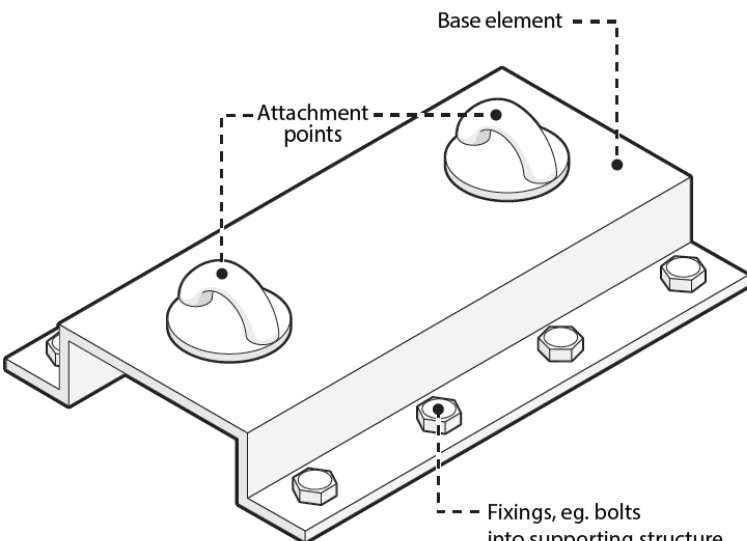

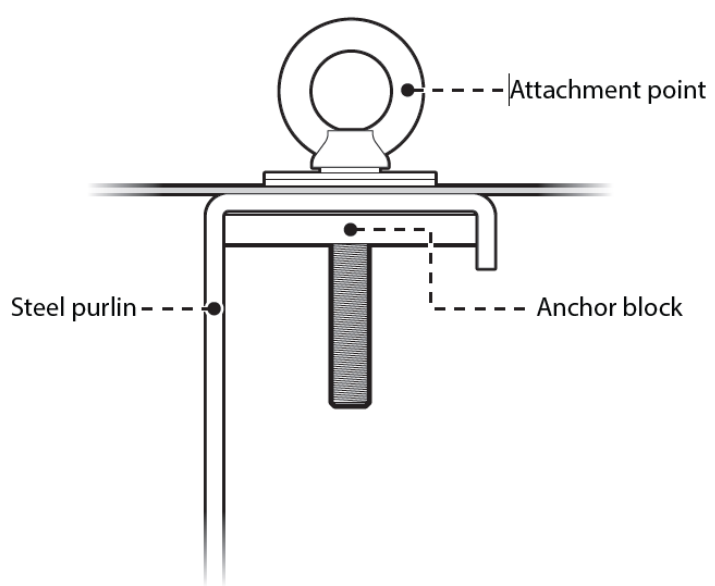



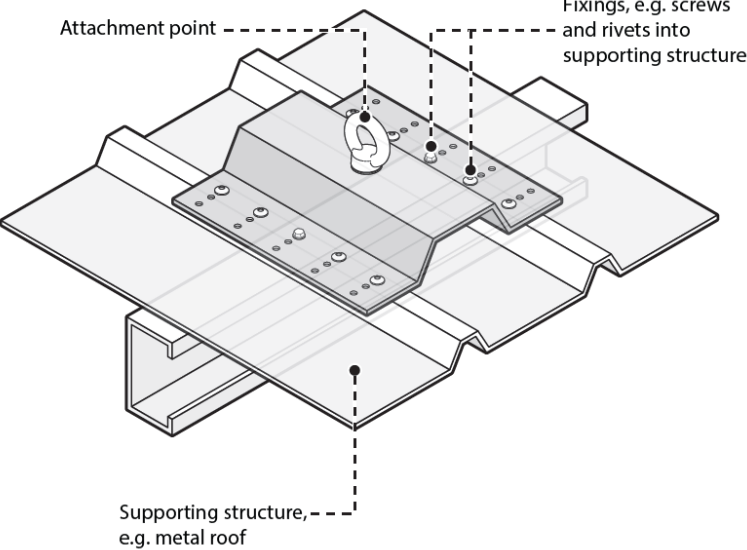

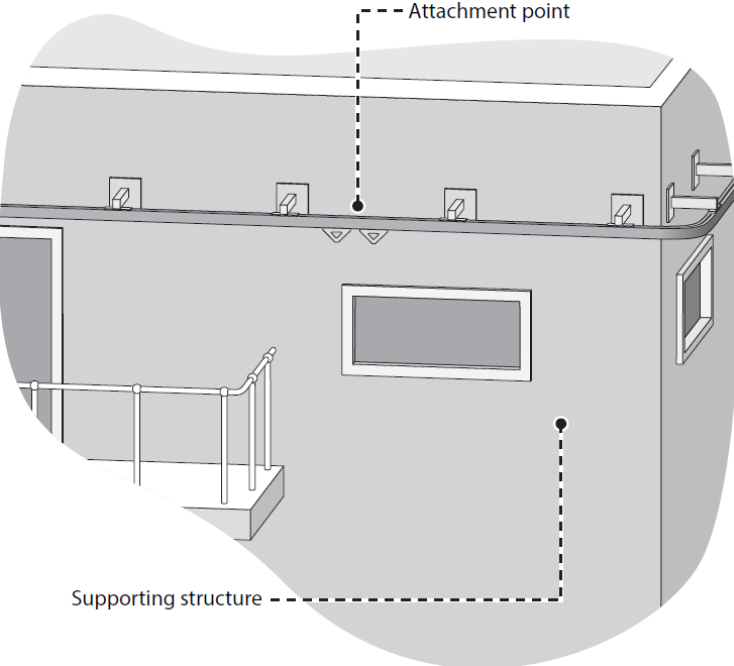

Figure 2 Examples of shear and tensile load

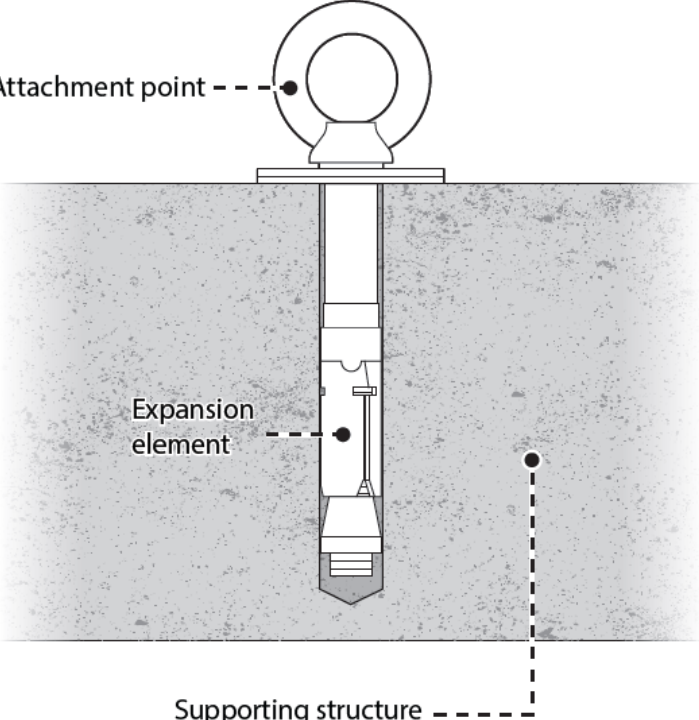

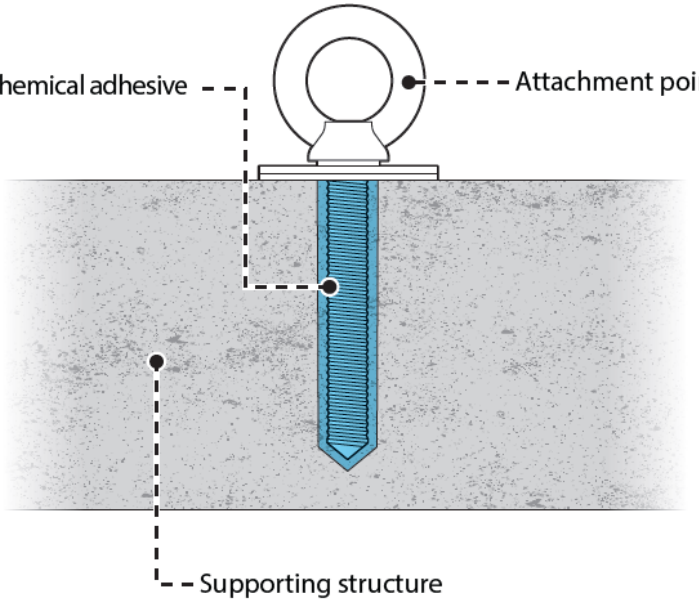

Some anchor devices are only suitable for rope access if loaded in shear. This means the anchor is loaded in a direction that is almost perpendicular to how the anchor is installed, so that the shear load is at least twice the tensile load. This is usually achieved if the angle of the attached rope does not exceed 20° to the supporting surface. If the direction of load is more in line with the anchor's installation, then the anchor is loaded in tension. You should seek information on the safe use of an anchor device from the manufacturer, supplier, or a competent person such as a qualified engineer.

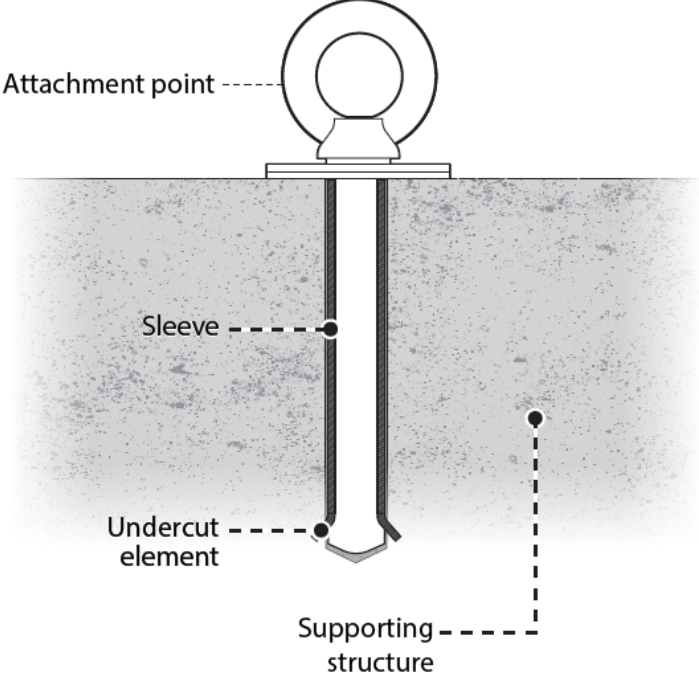

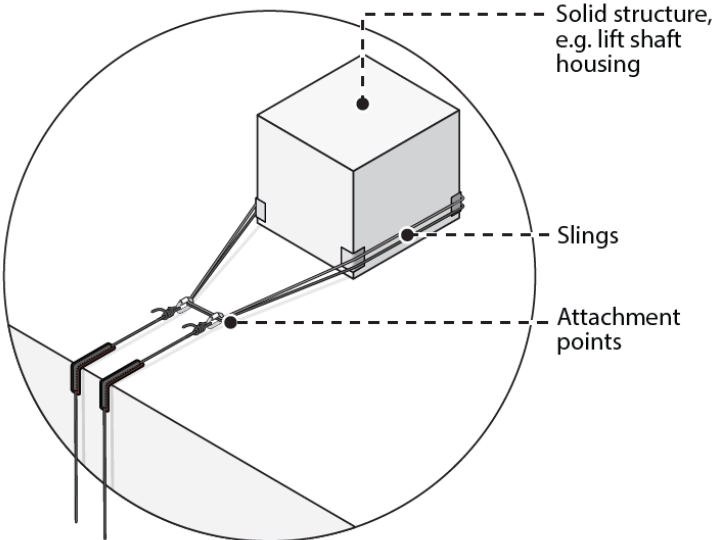

Table 2 Common types of anchor devices

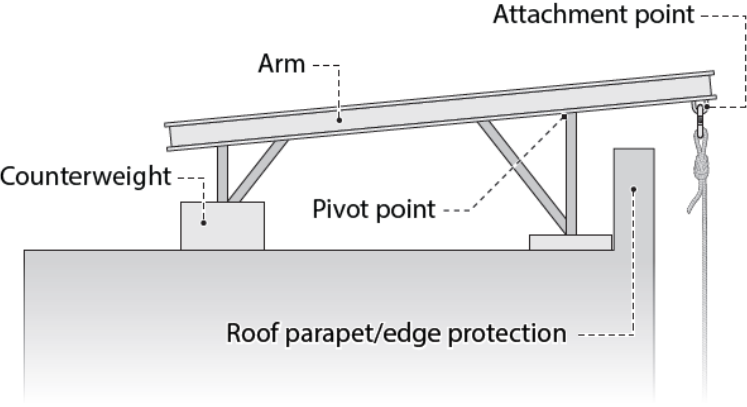

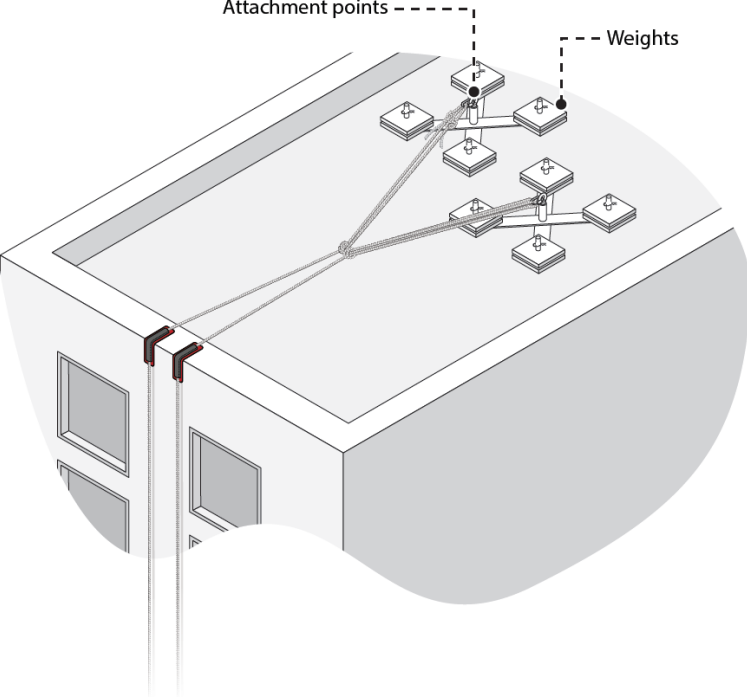

Anchor device	Suitable for industrial rope access systems?
<p>Through anchor</p>  <p>Through anchors pass all the way through a wall, floor, or other structural element.</p>	 <p>If correctly installed in line with manufacturer's recommendations in appropriate material, such as steel or concrete, and not in masonry or lighter weight materials.</p>
<p>Davit arm</p>  <p>A cantilevered device over balustrades, parapets, and curtain walls. They may be designed to be fixed in place, traverse a track, or relocated between permanently mounted bases.</p>	 <p>If correctly installed in line with manufacturer's recommendations in appropriate material, such as concrete, and not in masonry or lighter weight materials.</p>

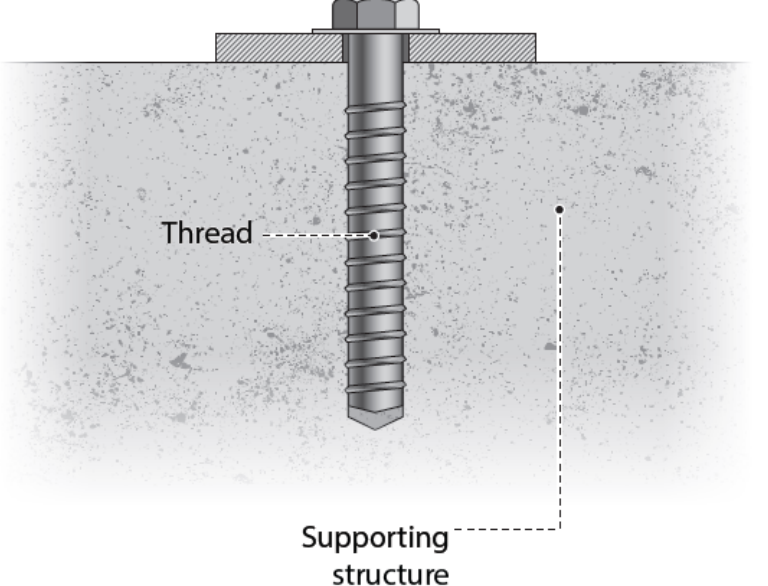

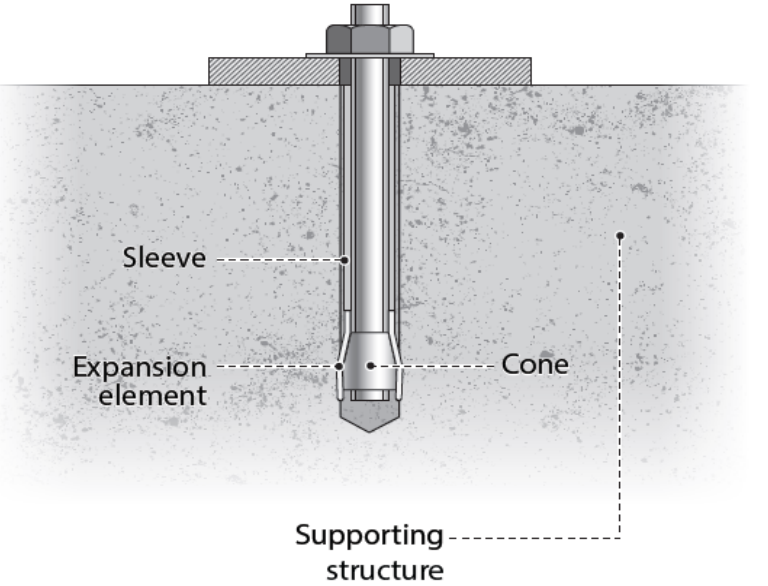

Anchor device	Suitable for industrial rope access systems?
<p>Paired anchor device</p>  <p>Attachment points</p> <p>Base element</p> <p>Fixings, eg. bolts into supporting structure</p> <p>A paired anchor device has two attachment points mounted on a single base and fixing elements to install it to the supporting surface. A typical design is a saddle construction, but there are many different designs for base elements, including a box, flat plate, or pedestal.</p>	 <p>If correctly installed in line with manufacturer's recommendations on a flat surface made of appropriate material, such as concrete, and not in masonry or lighter weight materials.</p>
<p>Purlin mount</p>  <p>Attachment point</p> <p>Steel purlin</p> <p>Anchor block</p> <p>Purlin mount anchors involve an anchor device being threaded through a hole in a purlin and fastened using a threaded anchor block which is drawn upwards and tightens against the underside of the purlin.</p>	 <p>If correctly installed in line with manufacturer's recommendations in a purlin that can withstand the potential loads of rope access work, including fall arrest.</p>

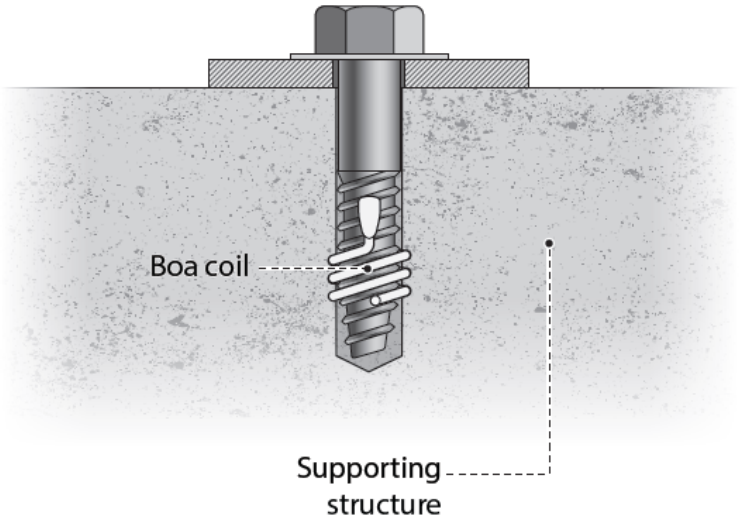

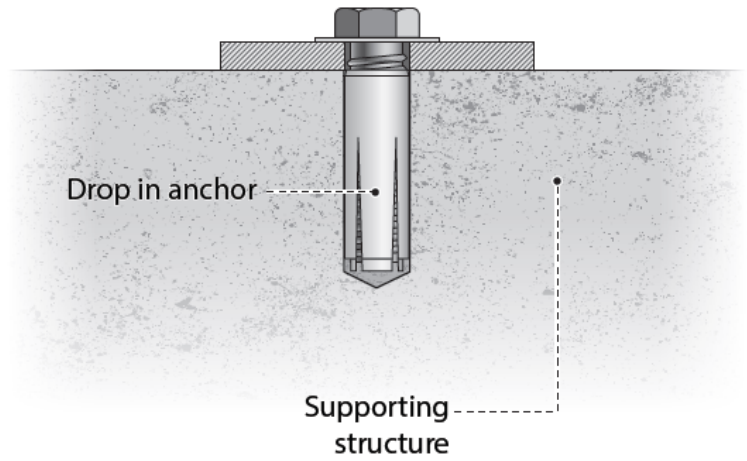

Anchor device	Suitable for industrial rope access systems?
<p>Surface mount</p>  <p>Attachment point</p> <p>Fixings, e.g. screws and rivets into supporting structure</p> <p>Supporting structure, e.g. metal roof</p> <p>Surface mount anchors are usually fastened to metal roof sheets.</p>	 <p>If designed for industrial rope access work and correctly installed in line with manufacturer's recommendations on a surface that can withstand the potential loads of rope access work, including fall arrest.</p> <p>This device relies on the fixings, roof sheets and substrate being able to sustain a 15 kN load. The strength of the supporting structure must be certified by a competent person.</p>
<p>Anchor rail</p>  <p>Attachment point</p> <p>Supporting structure</p> <p>Anchor rails are a type of rigid horizontal line, usually metal tubing, permanently fitted to the side of a structure. Attaching usually involves passing two slings around the rail or to two sliding attachment points if fitted.</p>	 <p>If correctly installed in line with manufacturer's recommendations on a supporting structure that can withstand the potential loads of rope access work, including fall arrest.</p>

Anchor device	Suitable for industrial rope access systems?
<p>Torque controlled</p>  <p>Torque-controlled anchors utilise a thick sleeve that is expanded in a pre-drilled concrete hole to create friction between the anchor and the hole.</p>	 <p>Only if loaded in shear.</p> <p>If correctly installed in line with manufacturer's recommendations in appropriate material, such as concrete, and not in masonry or lighter weight materials.</p>
<p>Chemical</p>  <p>Chemical anchors use an adhesive to create a bond between the anchor device and the concrete it is being mounted in.</p>	 <p>Only if loaded in shear.</p> <p>If correctly installed in line with manufacturer's recommendations in appropriate material, such as concrete, and not in masonry or lighter weight materials.</p> <p>Degradation of the chemical adhesive may occur over time.</p>

Anchor device	Suitable for industrial rope access systems?
<p data-bbox="193 275 331 315">Undercut</p>  <p data-bbox="193 1014 976 1182">Undercut anchors involve creating an undercut at the bottom of a pre-drilled hole using a special drill bit or with a self-drilling anchor. Once installed undercut anchors use the compressive strength of the concrete and are extremely strong.</p>	 <p data-bbox="1007 477 1316 510">Only if loaded in shear.</p> <p data-bbox="1007 528 1356 757">If correctly installed in line with manufacturer's recommendations in appropriate material, such as concrete, and not in masonry or lighter weight materials.</p>
<p data-bbox="193 1189 279 1229">Sling</p>  <p data-bbox="193 1821 983 2022">An anchor sling is a temporary anchor device. It is attached around a solid structure where it has been determined to be safe to do so by a competent person. Image shows an example setup using two anchor slings. This device provides a temporary anchor point where no other reliable anchor point exists.</p>	 <p data-bbox="1007 1373 1385 1570">An anchor sling should have a minimum breaking strength of 22 kN if made from man-made fibres or 15 kN if made from steel wire or chain.</p> <p data-bbox="1007 1592 1380 1753">Examples of a solid structure include a structure made from steel beams, a lift shaft housing, or a plant room.</p> <p data-bbox="1007 1776 1364 1937">You should check that the use of a structure as an anchor point does not conflict with building safety laws.</p>

Anchor device	Suitable for industrial rope access systems?
<p>Counterweight</p>  <p>A counterweight anchor is a temporary anchor device. It is typically a metal base loaded with weights, an attached arm, and a support to provide a pivot point. The arm projects over the edge to provide an attachment point. This device provides a temporary anchor point where no other reliable anchor point exists.</p>	 <p>A counterweight anchor relies on the mass of the counterweights and the position of the pivot point, which is the point where the arm becomes unsupported. Correct setup prevents the counterweights from lifting off the surface when the device comes under load.</p> <p>The counterweights should be steel, concrete or similar material that cannot leak or flow. Sand or water bags should not be used.</p>
<p>Deadweight</p>  <p>A deadweight anchor is a temporary anchor device (typically, a weighted metal base with an anchor point to which a line may be attached). The image shows an example setup using two deadweight anchors. This device provides a temporary anchor point where no other reliable anchor point exists.</p>	 <p>This device should not slip when under load of at least 15 kN when tested in the direction of expected load.</p> <p>This relies on surface friction. Without sufficient friction, a fall or repetitive loading and unloading may cause the device to slip or slide out of position. It should not be used on surfaces sloping downward more than 5°; if the surface is wet, insufficiently rough, or otherwise contaminated; or if conditions are icy.</p> <p>The weights should be steel, concrete or similar material that cannot leak or flow. Sand or water bags should not be used.</p>

Anchor device	Suitable for industrial rope access systems?
<p data-bbox="204 286 347 315">Screw bolt</p>  <p data-bbox="204 920 986 1048">Screw bolt anchors involve the anchor device cutting thread into a predrilled concrete hole. The pull-out resistance is based on the effectiveness of the grooves that are cut.</p>	 <p data-bbox="1010 456 1377 689">Screw bolts do not achieve the tight tolerances needed to ensure a safe anchor for industrial rope access work and are not recommended by manufacturers for use in industrial rope access work.</p> <p data-bbox="1010 707 1377 837">May be suitable if inspected and determined safe for the intended use by a competent person.</p>
<p data-bbox="204 1070 300 1099">Sleeve</p>  <p data-bbox="204 1704 986 1832">Sleeve anchors function similar to a torque-controlled anchor and rely on the expansion of a thin sleeve to create a friction connection between the anchor device and the concrete hole.</p>	 <p data-bbox="1010 1240 1377 1402">Sleeve anchors do not perform well under repeated loading applications like those encountered during industrial rope access work.</p> <p data-bbox="1010 1420 1377 1550">May be suitable if inspected and determined safe for the intended use by a competent person.</p>

Anchor device	Suitable for industrial rope access systems?
<p>Boa coil expansion bolt</p>  <p>A boa coil expansion anchor is a removable anchor and relies on the expansion of the boa coil to create a friction connection between the anchor device and the concrete hole.</p>	 <p>Boa coil expansion anchors are not designed to withstand the high loads encountered during industrial rope access work and are not recommended by manufacturers for use in industrial rope access work.</p> <p>May be suitable if inspected and determined safe for the intended use by a competent person.</p>
<p>Drop-in</p>  <p>Drop-in anchors work by inserting the anchor device into a pre-drilled hole. A stepped steel setting tool/punch is then used with a hammer to push a 'plug/wedge' of metal down towards the end of the anchor. This action causes the slotted bottom section of the anchor to expand outwards and hence wedge the anchor in the drilled hole.</p>	 <p>Drop-in anchors should not be used on new installations. Existing installed systems using drop-in anchors where the manufacturer has tested and approved the whole system may be suitable to be used where they are determined safe by a competent person.</p>

See AS/NZS 1891.4-2009 and AS/NZS 5532:2013 for further guidance on selection and use of anchor devices.

4.5.2. Anchor access and layout

As a PCBU, you must ensure the workplace layout allows workers to safely enter and exit a work area and have enough space to safely carry out work there, so far as is reasonably practicable. For industrial rope access work, this includes ensuring workers can connect and disconnect from the industrial rope access system without risk of falling, so far as is

reasonably practicable. Generally, permanent or temporary anchor points should be installed in a work area where an [exclusion zone](#) can be established and where, either:

- the edges are protected by barriers or guard rails to prevent workers from falling, or
- an anchor point is accessible before a worker is within 3 metres of an unguarded edge.

The layout of the system should be designed by a competent person who is familiar with the safe use of the system. They should consider the type of work to be carried out and where anchor points will be needed to control risks. The foreseeable directions of loading and anticipated potential loads should be established and taken into account when planning the anchor layout.

When anchor devices are installed, it is essential they are spaced apart correctly to prevent compromising the strength of the supporting structure. In rock or concrete, the minimum distance between anchors is usually considered to be the depth of the installed anchor, including any structural anchor. In masonry, the anchor devices should not be installed in the same or adjacent masonry units. Information on the minimum distances between anchors should be provided by the manufacturer or supplier of the anchor device. If this is not available, you must carry out, or arrange the carrying out of, any testing needed to ensure, so far as is reasonably practicable, the anchor devices are installed without risks to the health and safety of any person.

Installing additional anchors may be necessary for emergency rescues.

The anchors should be installed so they can only be loaded in the directions intended by the designer. If this is not practical, the area near the anchors should be clearly marked to show the limitations of loading.

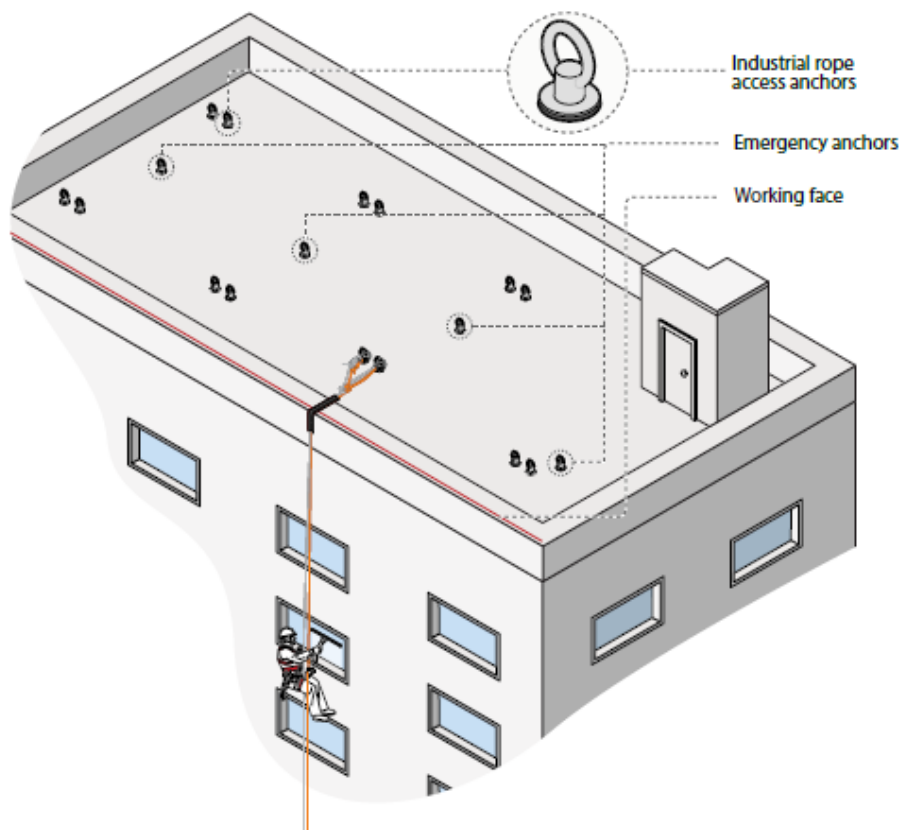


Figure 3 Example rooftop layout for an industrial rope access system

Two anchor points should be installed or placed directly above each work area to ensure each line can be safely attached to both anchors and to minimise pendulum effect. This is when the system acts as pendulum during or after a fall from a position located horizontally away from an anchor point. This can occur if the working line or an anchor fails. The pendulum effect can result in the worker hitting the ground or a floor (swing down) or an obstacle (swing back), or the working line being damaged or severed by contact with a sharp edge or other hazardous surface.

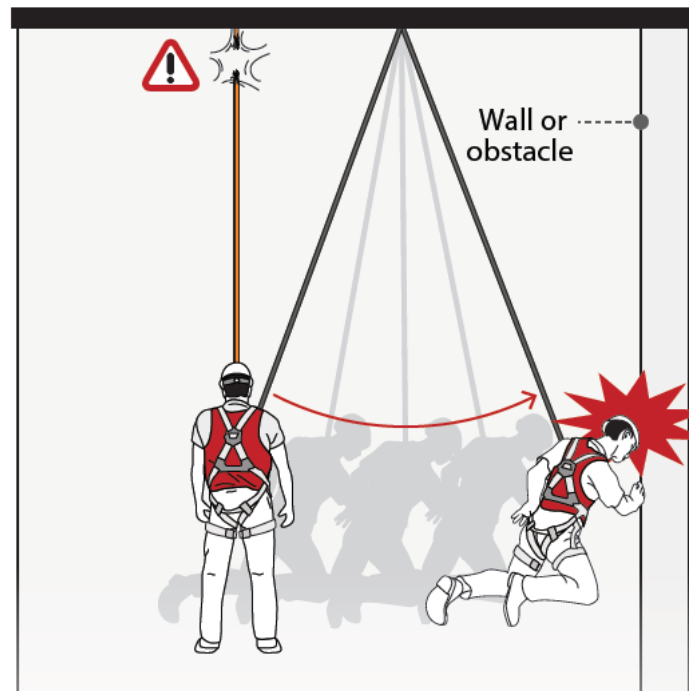


Figure 4 Example of pendulum effect on rope access worker when one line breaks

The risk of swing down and swing back can be minimised by installing anchor points as close together as is safe, installing additional anchor points such as intermediate anchorages, or using rigging techniques that attach each line to two anchors.

4.5.3. Rigging techniques

The simplest rigging technique is a basic anchor system, where the working line and safety line are each attached to a separate anchor device.

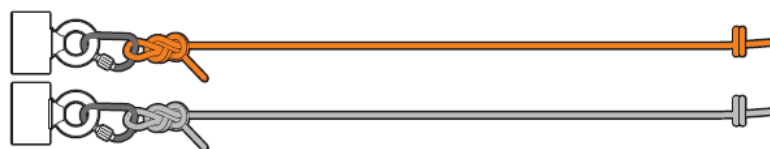


Figure 5 Basic anchor system

However, it is generally preferable to use a rigging technique that attaches both the working line and safety line to two anchors. These include Y-hang and other techniques that share the load of both lines across two anchors.

Loading sharing reduces the load on each anchor device, which helps minimise the risk of an anchor failing. This includes the load from the main working line and, should the main line fail, the load from the safety line when arresting a fall.

Attaching each line to two anchors also helps minimise the risk of uncontrolled swings. The wider apart the anchors, the more dangerous the pendulum effect from uncontrolled swings becomes.

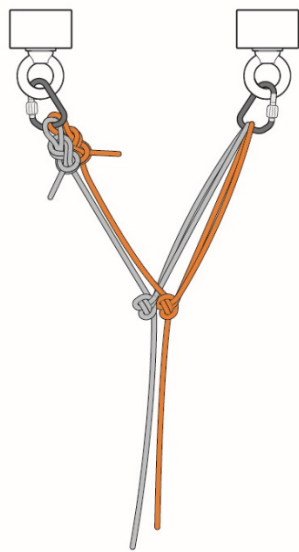


Figure 6 Small Y-hang

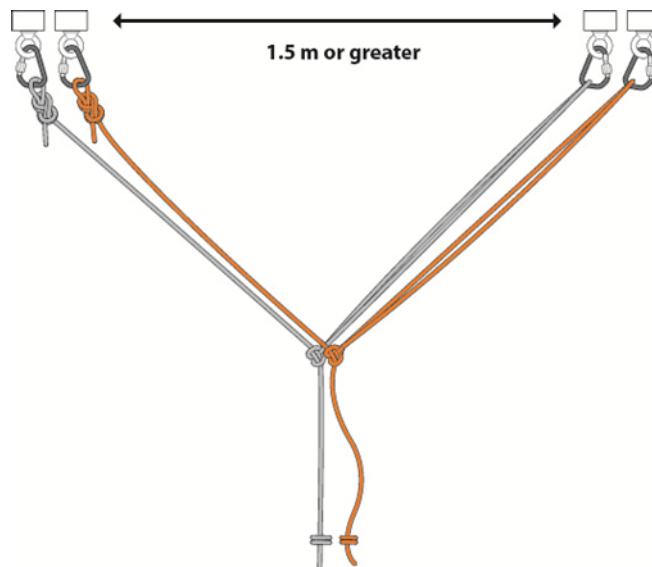


Figure 7 Wide Y-hang

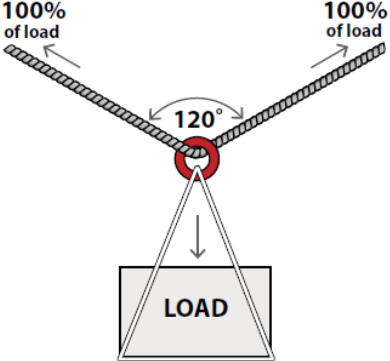

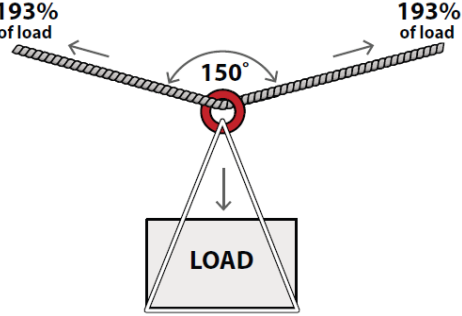

Using a small Y-hang or similar technique is also preferred where it is not practicable to have anchors directly above a work area.

If anchors are 1.5 m or more apart, there should be two anchor points on each side. This minimises the risk of uncontrolled swings as a result of any single point of failure.

When attached to two anchors using a Y-hang or similar technique, each line forms an angle (the Y angle). This angle should be as low as possible and should generally not exceed 90° and should never exceed 120° without additional control measures. For example, a horizontal anchor line system may exceed these angles but requires advice from a competent person to design, install and use safely.

Table 3 Load distribution for different rigging angles

Load distribution	Rigging angle	Suitable for industrial rope access systems?	Comments
	90°		Angle should be as low as possible and should generally not exceed 90°.

Load distribution	Rigging angle	Suitable for industrial rope access systems?	Comments
	120°		Angle should be as low as possible and should never exceed 120° without additional control measures.
	150°		Angle should never exceed 120° without additional control measures.

4.5.4. Inspection of anchors

As a PCBU, you must ensure that maintenance, inspection and, if necessary, testing of plant (including anchors) is carried out by a competent person. The maintenance, inspection and testing must be carried out:

- in accordance with the manufacturer's recommendations, or
- if there are no manufacturer's recommendations, in accordance with the recommendations of a competent person, or
- in relation to inspection, if it is not reasonably practicable to comply with the above, at least annually.

The nature and frequency of maintenance, inspection, and testing will vary depending on the nature of the workplace, its environment and the risks associated with the plant. For example, more frequent inspections may be required in harsh conditions.

Anchors should be load tested before first use and then at least annually.

For information on requirements relating to record keeping, see [Equipment selection, care and maintenance](#).

4.6. Rope protection

Working lines and safety lines should be rigged so they hang free and do not come into contact with hazardous surfaces (e.g. edges or abrasive or hot surfaces), or with hazardous plant (e.g. hot work tools or power tools), at any time during the rope access activity. Where this is not possible, working lines and safety lines should be protected. Rope protection may

be fixed on an edge, such as davit arms, rollers, metal edge plates and edge padding, or movable along the rope, such as a textile sheath that encapsulates the line.

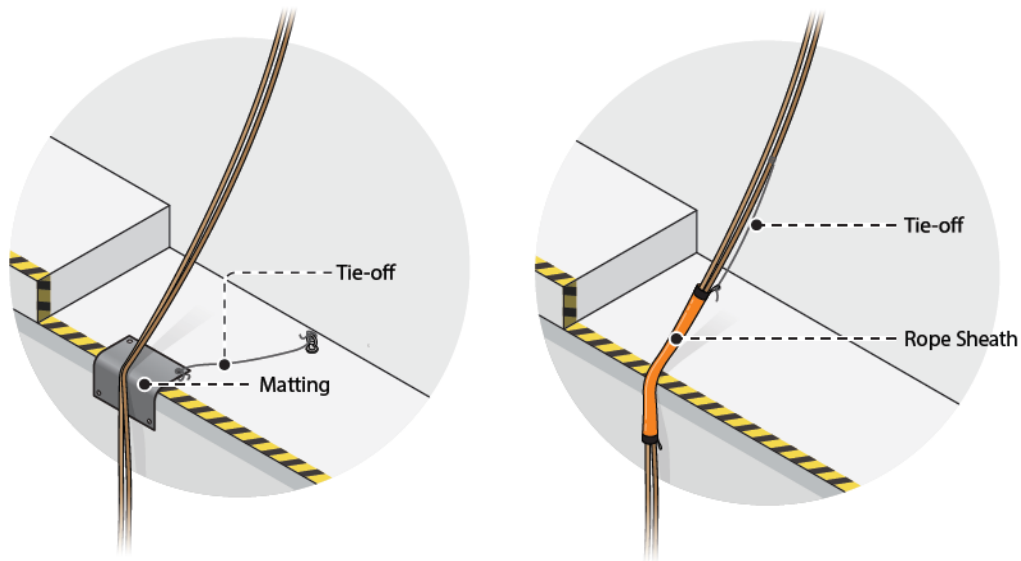


Figure 8 Examples of rope protection

Some sites may require rope protection at multiple points along each line. You should provide industrial rope access workers with access to protectors such as textile sheaths or rubber matting so they can be placed where line risks are identified. Rope protectors should be able to be tied off to keep protectors and lines in their intended place.

4.7. Exclusion zones

An exclusion zone is used to prevent people from entering an area. Generally, this includes providing clear signs, a physical barrier, and supervising access to the exclusion zone.

As a PCBU, you should ensure an exclusion zone is established:

- above a rope access work area to protect the anchors and lines from damage or alteration and to minimise trip hazards, and
- below a rope access work area to help minimise the risk of objects falling on people.

Sometimes exclusion zones are useful at other locations, such as balconies, that are within or near a rope access work area.

4.8. Use of tools and other work equipment

As a PCBU, you must eliminate the risk of an object falling on a person so far as is reasonably practicable. If this is not reasonably practicable, you must minimise the risk of an object falling on a person, including by:

- preventing an object from falling freely, e.g. attached to a separately anchored line, or
- if this is not reasonably practicable, providing a system to arrest an object's fall, so far as is reasonably practicable, e.g. a safety net or catch platform.

You may need a combination of controls to sufficiently minimise the risk of falling objects. This may include establishing an exclusion zone below a rope access work area.

Tools and work equipment attached to the rope access worker or rope systems should:

- be suitable for the intended work, and
- not impair the function of the main or backup systems.

Some tools are capable of cutting through working lines and safety lines. This includes hot work tools, like welders or flaming cutting tools, and power tools, like angle grinders, drills, or chain saws. You must eliminate this risk, so far as is reasonably practicable, by ensuring the work is performed on the ground or a solid structure. If this not possible, you must minimise the risk, so far as is reasonably practicable. This could include substituting the tool for something safer or using engineering controls to protect the rope.

Tools should be securely attached to the rope access worker's harness using cords or lanyards. Small items may also be secured in buckets or bags.

Bulky, awkward or heavy tools and equipment that have the potential to interfere with the function of the rope system or the worker's ability to work, should be suspended with a separate rope system secured to an independent anchor point.

4.9. Work environment hazards

Industrial rope access system work is regularly performed outdoors, often in remote or isolated conditions where workers are exposed to a range of environmental hazards.

Common hazards that should be considered before undertaking industrial rope access system work includes:

- Wind – Strong winds can cause rope tangles, dislodge tools and can potentially affect the stability of a rope access worker suspended on ropes.
- Wet – Equipment used on ropes such as descenders and back up devices may perform differently when used on wet ropes. Wet lines may also be less resistant to abrasion and can act as a tracking path for electrical currents.
- Cold – Hypothermia and frostbite can occur when working in cold conditions.
- Heat – Working in heat can result in a range of health issues including heat rash, fainting, heat exhaustion, burns and heat stroke.
- Solar UV radiation – Risk of skin cancer, sunburn and adverse health effects to the eyes. Solar UV radiation can also damage equipment after prolonged exposure.
- Non-environmental hazards – For example, radiation from transmitters.

If the risks from these hazards cannot be eliminated, then they must be minimised, so far as is reasonably practicable.

It is important to access a local weather forecast and site information prior to starting a rope access task and to get regular updates to ensure conditions remain safe. Where working in potentially hazardous conditions, as a PCBU, you must provide workers with PPE—such as safety gloves, protective clothing, and sunscreen—to minimise the risks to their health and safety.

Further information on managing the risks associated with the work environment and facilities can be found in the [model Code of Practice: *Managing the work environment and facilities*](#).

4.10. Hazardous manual tasks

Industrial rope access work involves manual tasks, whether working on the ground, on a roof, or suspended by rope.

As a PCBU, you must eliminate the risks to health and safety relating to musculoskeletal disorders from hazardous manual tasks so far as is reasonably practicable, for example by designing the work so hazardous manual tasks are not required. If this is not reasonably practicable, you must minimise the risks of hazardous manual tasks so far as is reasonably practicable in accordance with the hierarchy of control measures.

A hazardous manual task is one requiring a person to lift, lower, push, pull, carry or otherwise move, hold or restrain any person, animal or thing, that also involves repetitive or sustained force, high or sudden force, repetitive movement, sustained or awkward posture, or exposure to vibration.

Control measures may include:

- planning work to make the task less hazardous. For example, working in descent wherever possible to minimise more physically demanding ascending techniques.
- providing and ensuring mechanical aids are used where possible, such as ensuring a separately anchored line is used to manage the weight of high-pressure water jet hoses or power tool cables.
- ensuring the design of tools, equipment and PPE minimise the risks of manual handling.

When deciding what control measures to implement, you must consider all relevant matters that may contribute to a musculoskeletal injury, including:

- postures, movement, forces and vibration
- duration and frequency of the task
- the nature, size and weight or number of things involved in carrying out the hazardous manual task.

Further information can be found in the [model Code of Practice: Hazardous manual tasks](#).

4.11. Suspension trauma

Suspension trauma can occur with an industrial rope access system when a person has an arrested fall and is suspended in an upright, vertical position. The capacity of the lower legs to store large amounts of blood reduces the return of blood to the heart, slowing the heart rate, which can cause the person to faint. This may lead to renal failure and eventually death, depending on a person's susceptibility. The quick rescue of a person suspended in a harness, as soon as possible, is vital.

To prevent suspension trauma, you should ensure that:

- workers do not work alone when using a harness as fall protection
- workers use a harness that allows legs to be kept horizontal
- where the rescue is likely to take more than five minutes the harness and connection point used should allow the suspended worker to raise their legs to near horizontal, or the worker should carry straps to provide footholds

- workers are trained to do the following when they are hanging in a harness after a fall:
 - move their legs in the harness and push against any footholds, where these movements are possible. In some instances, the harness design and any injuries received may prevent this movement
 - move their legs or legs and body to a near horizontal position, where these movements are possible.

4.12. Overhead electric lines

Electric lines pose significant risks, including electrocution, arcing, explosion, fire causing burns, unpredictable cable whiplash and electrifying other objects including signs, poles, trees or branches. Whether carrying voltage of 400,000V or 230V, contact with these energised electric lines can be fatal. It is not necessary to touch an electric line to be electrocuted. A 'flashover' or 'arc' can electrocute a person close to a line conductor.

As a PCBU, you must ensure, so far as is reasonably practicable, that no person, plant or thing at the workplace comes within an unsafe distance of an overhead electric line.

If it is not reasonably practicable to ensure a safe distance, you must ensure that a risk assessment is conducted for the proposed work and control measures implemented are consistent with the risk assessment and any requirements of an electricity supply authority where it is responsible for the electric line.

The following should be considered:

- Are workers or plant likely to go near electric lines? If so, how close?
- Are overhead electric lines hard to see in the sky or are they hidden by trees?
- Has the relevant state or territory electricity supply authority been contacted for information about specific requirements when working near electric lines, including the qualifications required for those people working near electric lines?
- Have emergency rescue procedures been established, including calling the electricity supply authority to isolate the electricity supply before trying to rescue a person receiving an electric shock?

Further information can be found in the [model Code of Practice: *Managing electrical risks in the workplace*](#).

5. Glossary

anchor point is a secure point for attaching a lanyard, working line, safety line or other component of a fall arrest system, industrial rope access system, or restraint system. Anchors require specific load and impact capacities for their intended use.

ascender is a device used on a working line of a work positioning system. It is designed to allow controlled ascending or to maintain a stationary position.

building maintenance unit is a power-operated suspended working platform that is fixed permanently to a building or structure and used for building maintenance or window cleaning.

competent person is a person who has acquired through training, qualification or experience the knowledge and skills to carry out the task.

descender is a device used on a working line of a work positioning system. It is designed to allow controlled descending and short ascents or to maintain a stationary position.

duty holder is any person who owes a work health and safety duty under the WHS Act including a person conducting a business or undertaking, a designer, manufacturer, importer, supplier, installer of products or plant used at work (upstream duty holder), officer or a worker.

energy absorber is a device used to limit the deceleration in a fall. It reduces the deceleration force imposed when a fall is suddenly arrested, and correspondingly reduces the loadings on the anchorage and the person's body. The energy absorber may either be a separate item or manufactured as part of the lanyard.

fall means a fall by a person from one level to another.

fall arrest system means plant or material designed to safely stop a worker falling an uncontrolled distance and to reduce the impact of the fall. This includes an industrial safety net, a catch platform, or a safety harness system.

fall prevention device is material or equipment—or a combination of both—designed to prevent a fall for temporary work at heights, that once in place after initial installation does not require any ongoing adjustment, alteration or operation by any person to ensure its integrity. This includes secure fencing, edge protection, working platforms and covers.

harness is a body holding device. A harness-based personal fall protection system comprises of at least a harness, anchor/s and connecting components.

helmet is a hard or padded protective hat. A helmet designed for rope access work should always be worn when working in an industrial rope access system.

industrial rope access system is a type of work positioning system used for gaining access to, and working at, a workplace, usually by means of vertically suspended ropes.

karabiner is a coupling link with a safety closure.

lanyard is an assembly consisting of a line and components to connect a harness to a line or anchor point. A lanyard attached to a safety line usually incorporates an energy absorber. A lanyard attached to a working line may come with or without adjusters.

may indicates an optional course of action.

must indicates a legal requirement exists that must be complied with.

person conducting a business or undertaking (PCBU) is an umbrella concept which intends to capture all types of working arrangements or relationships. A PCBU includes a:

- company
- unincorporated body or association
- sole trader or self-employed person.

Individuals who are in a partnership that is conducting a business will individually and collectively be a PCBU. A volunteer association or elected members of a local authority will not be a PCBU.

person with management or control of plant at a workplace is a person conducting a business or undertaking to the extent that the business or undertaking involves the management or control of fixtures, fittings or plant, in whole or in part, at a workplace.

plant includes machinery, equipment, appliance, container, implement and tool components or anything fitted or connected to those things. Plant includes items as diverse as industrial rope access systems, lifts, cranes, computers, machinery, conveyors, forklifts, vehicles, power tools, quad bikes, mobile plant and amusement devices.

restraint technique is a work positioning system used to control a person's movement by physically preventing them from reaching a position at which there is a risk of a fall, for example an unprotected edge. It consists of a harness that is connected by a lanyard to an anchorage or horizontal line.

risk of a fall is a circumstance that exposes a worker while at work, or other person while at or in the vicinity of a workplace, to a risk of a fall that is reasonably likely to cause injury to the worker or other person. This includes circumstances in which the worker or other person is:

- in or on plant or a structure that is at an elevated level
- in or on plant that is being used to gain access to an elevated level
- in the vicinity of an opening through which a person could fall
- in the vicinity of an edge over which a person could fall
- on or in the vicinity of a surface through which a person could fall
- on or near the vicinity of a slippery, sloping or unstable surface.

rope protector is a sleeve or other item that protects a rope from abrasion, cuts, heat, or other damage.

safety line is a rope used in an industrial rope access system to arrest a fall if the working line fails. Also known as a backup line or secondary rope.

should indicates a recommended course of action.

swing down/swing back is a pendulum-like motion that occurs during or after a vertical fall from a position located horizontally away from an anchor point. This can result in the worker hitting the ground or a floor (swing down) or an obstacle (swing back), or the working line being damaged or severed by contact with a sharp edge or other hazardous surface.

worker is any person who carries out work for a person conducting a business or undertaking, including work as an employee, contractor or subcontractor (or their employee), self-employed person, outworker, apprentice or trainee, work experience student, employee of a labour hire company placed with a 'host employer' or a volunteer.

working line is a rope used in an industrial rope access system as part of a work positioning system. It is designed to carry the load during suspension, ascending and descending. Also known as the main line or primary rope.

workplace is any place where work is carried out for a business or undertaking and includes any place where a worker goes, or is likely to be, while at work. This may include offices, factories, shops, construction sites, vehicles, ships, aircraft or other mobile structures on land or water.

work positioning system means any plant or structure, other than a temporary work platform, that enables a person to be positioned and safely supported at a location for the duration of the relevant work being carried out. This includes restraint technique or an industrial rope access system.

Appendix A – Industrial rope access system checklist

Workplace location: Select to enter text.

Activities: Select to enter text, e.g. cleaning and maintenance, construction work, etc.

Assessed by: Select to enter text.

Date: Select to enter text.

If 'Yes' to either of the below, then consider if an industrial rope access system should not be used

Managing the risk of a fall	Yes	No
Can any work activities be done on the ground or a solid construction? <ul style="list-style-type: none"> You must eliminate the risk of fall, so far as is reasonably practicable. 	<input type="checkbox"/>	<input type="checkbox"/>
Can the risk of a fall be minimised using a fall prevention device, such as guard rails, barrier, scaffolding, building maintenance unit, or an elevating work platform? <ul style="list-style-type: none"> You must provide a safe system of work, including providing a fall prevention device if it is reasonably practicable. 	<input type="checkbox"/>	<input type="checkbox"/>

If 'No' to any of the below, then review risk controls

Workplace assessment	Yes	No
Can workers safely enter and exit work areas and access anchor points without the risk of a fall?	<input type="checkbox"/>	<input type="checkbox"/>
Have all anchor points been inspected by a competent person and confirmed safe for rope access work? <ul style="list-style-type: none"> Provide instructions for any proprietary anchor systems. 	<input type="checkbox"/>	<input type="checkbox"/>
Can each rope access worker remain attached to two lines, at all times, during the planned work? <ul style="list-style-type: none"> If possible, working line and safety line should each be rigged to load share across two anchor points. 	<input type="checkbox"/>	<input type="checkbox"/>
Are two anchor points installed directly above each work area? <ul style="list-style-type: none"> If not, you should provide deviation anchors that can support the potential load. 	<input type="checkbox"/>	<input type="checkbox"/>
Can rope access lines be rigged to hang free from hazardous surfaces, including sharp edges, abrasive or hot surfaces, or hazardous plant? <ul style="list-style-type: none"> You must eliminate hazardous surfaces. If not reasonably practicable, you must minimise the risk of rope damage. You should: <ul style="list-style-type: none"> keep lines away from hazards, e.g. using deviations. if not possible, make surfaces safer, e.g. using rollers. if not possible, provide rope protection, e.g. padding or sleeves. 	<input type="checkbox"/>	<input type="checkbox"/>
Can workers avoid performing hazardous work, like hot work or using power tools, while using a rope access system? <ul style="list-style-type: none"> If not, you must minimise the risks, for example, provide rope protection like steel lanyards or hot-work blankets. 	<input type="checkbox"/>	<input type="checkbox"/>
Can exclusion zones be established to protect anchors and lines and minimise the risk of objects falling on people? <ul style="list-style-type: none"> This includes above and below rope access work areas, using signs, barriers, and supervising access. 	<input type="checkbox"/>	<input type="checkbox"/>

If 'No' to any of the below, then review risk controls

Planning work	Yes	No
<p>Is there a plan for the rope access work, including an agreed safe system of work?</p> <ul style="list-style-type: none"> Workers and all relevant duty holders must be consulted on any matters affecting work health and safety. A Safe Work Method Statement (SWMS) must be prepared before carrying out high risk construction work. 	<input type="checkbox"/>	<input type="checkbox"/>
<p>Is there an emergency plan in place, including an agreed rescue method?</p> <ul style="list-style-type: none"> You must ensure trained workers are available to help in any situation in the workplace and that rescue equipment and first aid is ready and accessible. Rope access lines should be rigged for rescue. 	<input type="checkbox"/>	<input type="checkbox"/>
<p>Will workplace conditions remain safe during the rope access work?</p> <ul style="list-style-type: none"> Look out for strong winds, storms, heat, cold, and solar UV radiation. You must consult, coordinate, and cooperate with other duty holders at the workplace to minimise the risk of other activities interfering with the rope access work. 	<input type="checkbox"/>	<input type="checkbox"/>
<p>Have all rope access workers been provided information, training and instruction about the workplace prior to commencing work?</p> <ul style="list-style-type: none"> This includes a site induction about the hazards and risks at the workplace that may increase the risks to rope access workers. 	<input type="checkbox"/>	<input type="checkbox"/>
Work method	Yes	No
<p>Are all rope access workers trained and competent at the tasks they're assigned and the equipment and techniques they will use?</p> <ul style="list-style-type: none"> PCBUs should ensure any rope access worker they engage or direct has a current certificate of competency (or similar). 	<input type="checkbox"/>	<input type="checkbox"/>
<p>Will rope access workers be able to effectively communicate with each other, and other necessary persons, at all times?</p> <ul style="list-style-type: none"> You must ensure the system of work includes effective communication with any isolated worker. 	<input type="checkbox"/>	<input type="checkbox"/>
<p>Will all tools and objects be prevented from falling or have their fall arrested?</p> <ul style="list-style-type: none"> This includes securing tools to lanyards or suspending on a separately anchored line, or using a safety net or catch platform. 	<input type="checkbox"/>	<input type="checkbox"/>
<p>Will bulky, awkward, or heavy tools be suspended on a separately anchored line?</p>	<input type="checkbox"/>	<input type="checkbox"/>
Equipment	Yes	No
<p>Has the condition of rope access systems and equipment been checked by a competent person before use?</p> <ul style="list-style-type: none"> You must maintain, inspect, and test plant as recommended by the manufacturer or a competent person. 	<input type="checkbox"/>	<input type="checkbox"/>
<p>Do workers have the equipment they need to ensure a safe system of work?</p> <ul style="list-style-type: none"> For example, suitable full body harness, fail-to-safe descenders, back-up systems, rope protectors, etc. 	<input type="checkbox"/>	<input type="checkbox"/>
<p>Do workers have sufficient personal protective equipment for their tasks?</p> <ul style="list-style-type: none"> This includes a helmet designed for rope access work and other PPE as required by the environment and task. 	<input type="checkbox"/>	<input type="checkbox"/>